

# VACUUM FITTINGS & COMPONENTS CATALOGUE

A comprehensive range of NW/KF and ISO vacuum flanges, adaptors, reducers, weld stubs, flexible pipelines, O rings, clamps, etc, with dimensional drawings



MechaTech Systems Ltd,  
Unit 9 Brunel Way,  
Thornbury Industrial Estate,  
Thornbury, Bristol, UK. BS35 3UR  
Registered in England and Wales No. 06469333



# VACUUM FITTINGS and COMPONENTS

MechaTech Systems supply own-range KF (NW), ISO and CF vacuum fittings, often available from stock.

As manufacturers of High Vacuum Systems and LyoDry Freeze Dryers, we understand the need for top quality and a fast turnaround. We maintain extensive stocks of NW and ISO Adaptors, T-pieces, Blank Flanges, Weld Stubs, Nozzles, Reducers, Elbows, Flexible Pipelines, Clamps, O rings and centring rings.

Unsure which vacuum components you need? Our experienced sales team will be pleased to help. We can cross reference most major manufacturers' part numbers too. We also supply and service vacuum pumps. We receive excellent feedback!

For any further information, a quotation or to place an order, please contact us:  
enquiries@mechatechsystems.co.uk / 01454 414723

## CONTENTS

<a href="#">NW/KF BLANK FLANGES AND FULL NIPPLES.....</a>	<a href="#">3-4</a>
<a href="#">NW/KF LONG AND SHORT FLANGE WELD STUBS, WELD SOCKET FLANGE.....</a>	<a href="#">5-6</a>
<a href="#">NW/KF CROSS PIECES AND REDUCING CROSS, REDUCING PIECES.....</a>	<a href="#">7-8</a>
<a href="#">NW/KF T- PIECES AND REDUCING T PIECE, ELBOWS AND COUPLING BODY.....</a>	<a href="#">9-10</a>
<a href="#">NW/KF RIFFLED NOZZLES, ADAPTORS.....</a>	<a href="#">11-12</a>
<a href="#">NW/KF FLEXIBLE BELLOW AND FLEXIBLE PIPELINES.....</a>	<a href="#">13</a>
<a href="#">NW/KF CLAMPS.....</a>	<a href="#">14-15</a>
<a href="#">NW/KF O RINGS WITH CENTRING RINGS AND SEALS.....</a>	<a href="#">16-19</a>
<a href="#">ISO ADAPTING PIECE, T-PIECE AND CROSS PIECE.....</a>	<a href="#">20</a>
<a href="#">ISO TO NW REDUCING CROSS.....</a>	<a href="#">21</a>
<a href="#">ISO BLANK FLANGE, BORED FLANGE AND COLLAR WELD STUB.....</a>	<a href="#">22</a>
<a href="#">ISO NIPPLE AND ELBOW.....</a>	<a href="#">23</a>
<a href="#">ISO FLEXIBLE BELLOWS AND PIPELINES.....</a>	<a href="#">24</a>
<a href="#">ISO TRAPPED O RINGS, CENTRING RING WITH O RING AND ROTABLE FLANGE.....</a>	<a href="#">25-26</a>
<a href="#">ISO CLAW CLAMPS.....</a>	<a href="#">27</a>

# NW / KF VACUUM FITTINGS

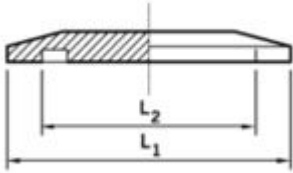

BLANK FLANGE - ALUMINIUM					
SIZE	L1	L2	L3	D	PART NUMBERS
NW10	30	12.2			KA-10-026
NW16	30	17.2			KA-16-026
NW25	40	26.2			KA-25-026
NW40	55	41.2			KA-40-026

BLANK FLANGE - STAINLESS STEEL					
SIZE	L1	L2	L3	D	PART NUMBERS
NW10	30	12.2			KS-10-026
NW16	30	17.2			KS-16-026
NW25	40	26.2			KS-25-026
NW40	55	41.2			KS-40-026
NW50	75	52.2			KS-50-026



# NW / KF VACUUM FITTINGS

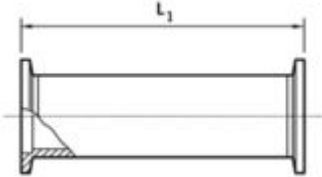

FULL NIPPLE - ALUMINIUM					
SIZE	L1	L2	L3	D	PART NUMBERS
NW10	60				KA-10-028
NW16	80				KA-16-028
NW25	100				KA-25-028
NW40	130				KA-40-028

FULL NIPPLE - STAINLESS STEEL					
SIZE	L1	L2	L3	D	PART NUMBERS
NW10	60				KS-10-028
NW16	80				KS-16-028
NW25	100				KS-25-028
NW40	130				KS-40-028
NW50	140				KS-50-028



# NW / KF VACUUM FITTINGS

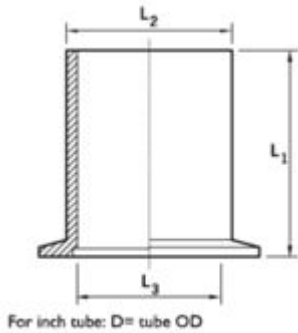

LONG FLANGE WELD STUB - STAINLESS STEEL					
SIZE	L1	L2	L3	D	PART NUMBERS
NW10	70	15	10		KS-10-025
NW16	70	20	16		KS-16-025
NW25	70	28	24		KS-25-025
NW40	70	44.5	41		KS-40-025
NW50	70	57	51		KS-50-025

LONG FLANGE WELD STUB FOR INCH TUBE - STAINLESS STEEL					
SIZE	L1	L2	L3	D	PART NUMBERS
NW10	40	12.7	9.3	½	KS-10-006
NW16	40	19.1	15.7	¾	KS-16-007
NW25	40	25.4	22	1	KS-25-008
NW40	40	38.1	34.7	1½	KS-40-009
NW50	40	50.8	47.4	2	KS-50-010



# NW / KF VACUUM FITTINGS

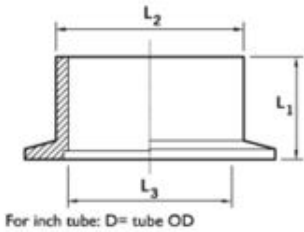

SHORT FLANGE WELD STUB - STAINLESS STEEL					
SIZE	L1	L2	L3	D	PART NUMBERS
NW10	30	15	10		KS-10-024
NW16	30	20	16		KS-16-024
NW25	30	28	24		KS-25-024
NW40	30	44.5	41		KS-40-024
NW50	30	57	51		KS-50-024

SHORT FLANGE WELD STUB FOR INCH TUBE - STAINLESS STEEL					
SIZE	L1	L2	L3	D	PART NUMBERS
NW10	12.7	12.7	9.3	½	KS-10-001
NW16	12.7	19.1	15.7	¾	KS-16-002
NW25	12.7	25.4	22	1	KS-25-003
NW40	19.1	38.1	34.7	1½	KS-40-004
NW50	19.1	50.8	47.4	2	KS-50-005

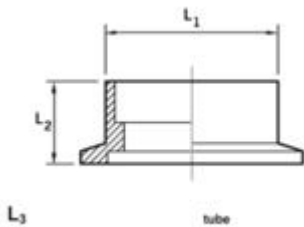

WELD SOCKET FLANGE FOR INCH TUBE - STAINLESS STEEL					
SIZE	L1	L2	L3	D	PART NUMBERS
NW16	15.5	12.7	12.7	½	KS-16-011
NW16	22.1	12.7	19.1	¾	KS-16-012
NW25	28.6	12.7	25.4	1	KS-25-013
NW40	44.5	12.7	38.1	1½	KS-40-014
NW50	57.2	15.7	50.8	2	KS-50-015

# NW / KF VACUUM FITTINGS

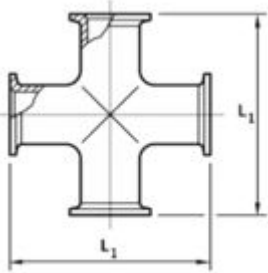

CROSS PIECE - ALUMINIUM					
SIZE	L1	L2	L3	D	PART NUMBERS
NW10	60				KA-10-031
NW16	80				KA-16-031
NW25	100				KA-25-031
NW40	130				KA-40-031

CROSS PIECE - STAINLESS STEEL					
SIZE	L1	L2	L3	D	PART NUMBERS
NW10	60				KS-10-031
NW16	80				KS-16-031
NW25	100				KS-25-031
NW40	130				KS-40-031
NW50	140				KS-50-031

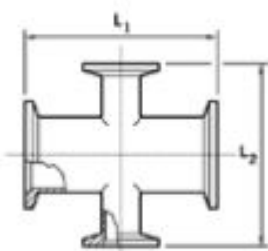

REDUCING CROSS - STAINLESS STEEL					
SIZE	L1	L2	L3	D	PART NUMBERS
NW25/10	70	70			KS-25-049
NW25/16	100	80			KS-25-047
NW40/16	130	80			KS-40-047
NW40/25	130	100			KS-40-048
NW50/25	140	100			KS-50-048

# NW / KF VACUUM FITTINGS

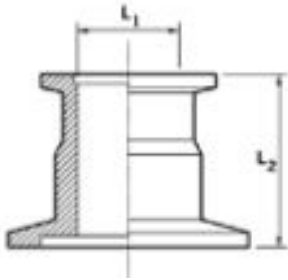

REDUCING PIECE - ALUMINIUM					
SIZE	L1	L2	L3	D	PART NUMBERS
NW25/10	10	40			KA-25-042
NW25/16	10	40			KA-25-043
NW40/25	24	40			KA-40-044
NW40/16	16	40			KA-40-043
NW50/16	16	40			KA-50-043
NW50/25	24	40			KA-50-044
NW50/40	41	40			KA-50-045

REDUCING PIECE - STAINLESS STEEL					
SIZE	L1	L2	L3	D	PART NUMBERS
NW25/10	10	40			KS-25-042
NW25/16	16	40			KS-25-043
NW40/25	16	40			KS-40-044
NW40/16	24	40			KS-40-043
NW50/16	16	40			KS-50-043
NW50/25	24	40			KS-50-044
NW50/40	40	40			KS-50-045



# NW / KF VACUUM FITTINGS

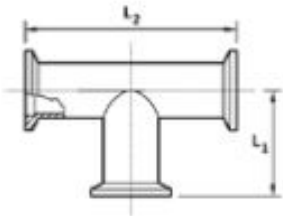

T-PIECE - ALUMINIUM					
SIZE	L1	L2	L3	D	PART NUMBERS
NW10	30	60			KA-10-030
NW16	40	80			KA-16-030
NW25	50	100			KA-25-030
NW40	65	130			KA-40-030

T-PIECE - STAINLESS STEEL					
SIZE	L1	L2	L3	D	PART NUMBERS
NW10	30	60			KS-10-030
NW16	40	80			KS-16-030
NW25	50	100			KS-25-030
NW40	65	130			KS-40-030
NW50	70	140			KS-50-030

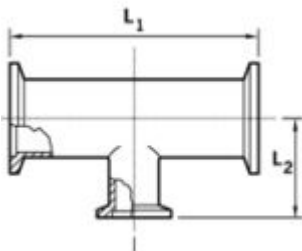

REDUCING T-PIECE - STAINLESS STEEL					
SIZE	L1	L2	L3	D	PART NUMBERS
NW25/16	100	27.4			KS-25-040
NW40/16	130	33.5			KS-40-040
NW40/25	130	65			KS-40-041
NW50/16	140	40			KS-50-040
NW50/25	140	65			KS-50-041

# NW / KF VACUUM FITTINGS

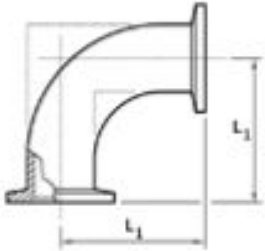

ELBOW 90° - ALUMINIUM					
SIZE	L1	L2	L3	D	PART NUMBERS
NW10	30				KA-10-029
NW16	40				KA-16-029
NW25	50				KA-25-029
NW40	65				KA-40-029

ELBOW 90° - STAINLESS STEEL					
SIZE	L1	L2	L3	D	PART NUMBERS
NW10	30				KS-10-029
NW16	40				KS-16-029
NW25	50				KS-25-029
NW40	60				KS-40-029
NW50	80.5				KS-50-029

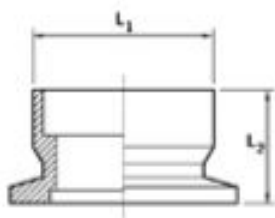

COUPLING BODY - BRASS					
SIZE	L1	L2	L3	D	PART NUMBERS
NW10	18	13			C105-11-328
NW25	32	20			C105-14-328
NW40	46	18			C105-16-628

# NW / KF VACUUM FITTINGS

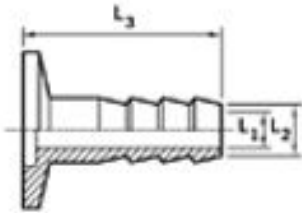

RIFFLED NOZZLE - ALUMINIUM					
SIZE	L1	L2	L3	D	PART NUMBERS
NW10	7	12	40		KA-10-032
NW16	7	12	40		KA-16-032
NW25	7	12	40		KA-25-032
NW40	7	12	40		KA-40-032

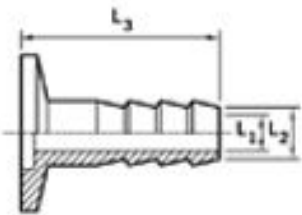

RIFFLED NOZZLE - STAINLESS STEEL					
SIZE	L1	L2	L3	D	PART NUMBERS
NW10	7	12	40		KS-10-032
NW16	7	12	40		KS-16-032
NW25	7	12	40		KS-25-032
NW40	7	12	40		KS-40-032

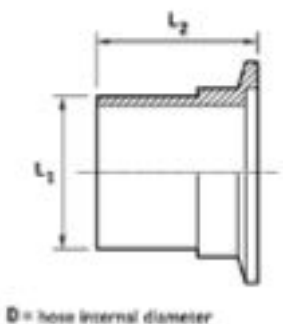

ADAPTOR PVC HOSE - STAINLESS STEEL					
SIZE	L1	L2	L3	D	PART NUMBERS
NW10/ 1/2" HOSE	12.7	32		12.7	KS-10-016
NW16/ 1/2" HOSE	12.7	32		12.7	KS-16-016
NW16/ 3/4" HOSE	19.1	32		19.1	KS-16-017
NW25/1" HOSE	25.4	38.1		25.4	KS-25-018
NW40/ 1 1/2" HOSE	38.1	50		38.1	KS-40-019
NW50/2" HOSE	47.4	55		50.8	KS-50-020

# NW / KF VACUUM FITTINGS

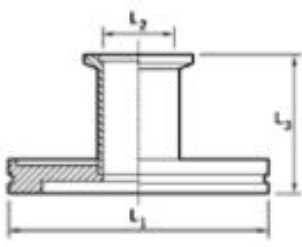

ADAPTOR NW/ISO - STAINLESS STEEL					
SIZE	L1	L2	L3	D	PART NUMBERS
NW25/ISO63	95	25	50		IS-63-044
NW40/ISO63	95	40	50		IS-63-045
NW40/ISO100	130	40	50		IS-10-045
NW50/ISO100	130	50	50		IS-10-055



# NW / KF VACUUM FITTINGS

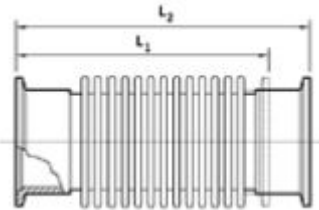

## FLEXIBLE BELLOWS - STAINLESS STEEL

SIZE	L1	L2	L3	D	PART NUMBERS
NW10	65	85			KS-10-046
NW16	65	85			KS-16-046
NW25	65	85			KS-25-046
NW40	65	85			KS-40-046
NW50	80	100			KS-50-046

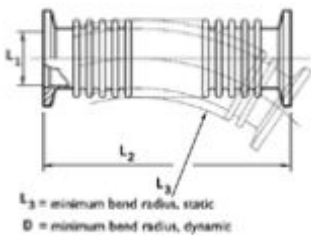

## FLEXIBLE PIPELINES - STAINLESS STEEL

SIZE	L1	L2	L3	D	PART NUMBERS
NW10	12.2	250	30	100	KS-10-021
NW16	17.2	250	30	100	KS-16-021
NW25	26.2	250	50	210	KS-25-021
NW40	41.2	250	80	260	KS-40-021
NW50	52.2	250	100	320	KS-50-021
NW10	12.2	500	30	100	KS-10-022
NW16	17.2	500	30	130	KS-16-022
NW25	26.2	500	50	210	KS-25-022
NW40	41.2	500	80	260	KS-40-022
NW50	52.2	500	100	320	KS-50-022
NW10	12.2	1000	30	100	KS-10-023
NW16	17.2	1000	30	130	KS-16-023
NW25	26.2	1000	50	210	KS-25-023
NW40	41.2	1000	80	260	KS-40-023
NW50	52.2	1000	100	320	KS-50-023

# NW / KF VACUUM FITTINGS

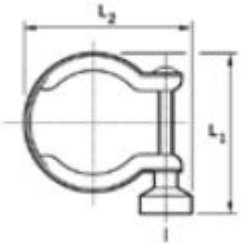

CLAMPING RING - STAINLESS STEEL					
SIZE	L1	L2	L3	D	PART NUMBERS
NW10/16	44	46			C105-12-401
NW20/25	60	60			C105-14-401
NW32/40	73	75			C105-16-401
NW50	90	96			C105-17-401

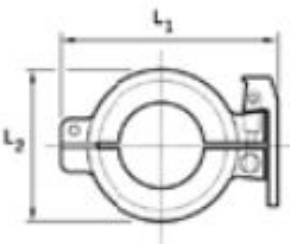

HINGED CLAMP - ALUMINIUM					
SIZE	L1	L2	L3	D	PART NUMBERS
NW10/16	68	40			C105-12-402
NW20/25	80	50			C105-14-402
NW32/40	95	66			C105-16-402

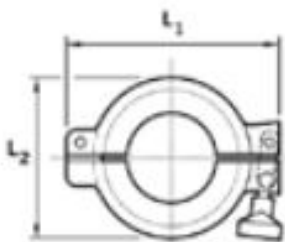

SWING CLAMP - ALUMINIUM					
SIZE	L1	L2	L3	D	PART NUMBERS
NW10/16	62	40			KA-10-036
NW20/25	75	50			KA-25-036
NW32/40	90	66			KA-40-036
NW50	120	86			KA-50-036

# NW / KF VACUUM FITTINGS

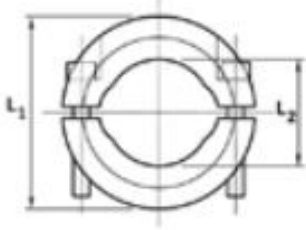

CLAMP (METAL SEALS) - STAINLESS STEEL					
SIZE	L1	L2	L3	D	PART NUMBERS
NW10/16	54	22			KS-10-037
NW20/25	64	32			KS-25-037
NW32/40	82	47			KS-40-037
NW50	112	62			KS-50-037

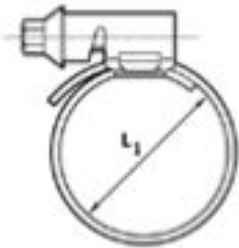

PVC HOSE CLAMP - STAINLESS STEEL					
SIZE	L1	L2	L3	D	PART NUMBERS
NW10/16	25				KS-10-039
NW25	36				KS-25-039
NW40	50				KS-40-039
NW50	60				KS-50-039



# NW / KF VACUUM FITTINGS

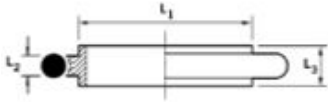

<b>CENTERING RING WITH O-RING FLUOROELASTOMER / STAINLESS STEEL CARRIER</b>					
<b>SIZE</b>	<b>L1</b>	<b>L2</b>	<b>L3</b>	<b>D</b>	<b>PART NUMBERS</b>
NW10	12	3.9	8		KS-10-127
NW16	17	3.9	8		KS-16-127
NW25	26	3.9	8		KS-25-127
NW40	41	3.9	8		KS-40-127
NW50	52	3.9	8		KS-50-127

<b>CENTERING RING WITH O-RING FLUOROELASTOMER / ALUMINIUM CARRIER</b>					
<b>SIZE</b>	<b>L1</b>	<b>L2</b>	<b>L3</b>	<b>D</b>	<b>PART NUMBERS</b>
NW10	12	3.9	8		KA-10-127
NW16	17	3.9	8		KA-16-127
NW25	26	3.9	8		KA-25-127
NW40	41	3.9	8		KA-40-127
NW50	52	3.9	8		KA-50-127



# NW / KF VACUUM FITTINGS

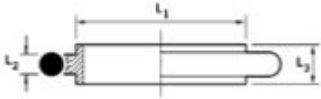

## CENTERING RING WITH O-RING NITRILE / STAINLESS STEEL CARRIER

SIZE	L1	L2	L3	D	PART NUMBERS
NW10	12	3.9	8		KS-10-227
NW16	17	3.9	8		KS-16-227
NW25	26	3.9	8		KS-25-227
NW40	41	3.9	8		KS-40-227
NW50	52	3.9	8		KS-50-227

## CENTERING RING WITH O-RING NITRILE / ALUMINIUM CARRIER

SIZE	L1	L2	L3	D	PART NUMBERS
NW10	12	3.9	8		KA-10-227
NW16	17	3.9	8		KA-16-227
NW25	26	3.9	8		KA-25-227
NW40	41	3.9	8		KA-40-227
NW50	52	3.9	8		KA-50-227

# NW / KF VACUUM FITTINGS

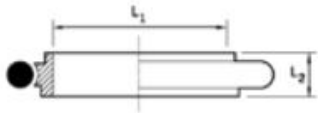

<b>ADAPTING CENTERING RING WITH O-RING FLUOROELASTOMER / STAINLESS STEEL CARRIER</b>					
SIZE	L1	L2	L3	D	PART NUMBERS
NW10/16	10	8			KS-10-134

<b>ADAPTING CENTERING RING WITH O-RING NITRILE / STAINLESS STEEL CARRIER</b>					
SIZE	L1	L2	L3	D	PART NUMBERS
NW10/16	10	8			KS-10-234



<b>CENTERING RING WITH SCREEN FLUOROELASTOMER / STAINLESS STEEL</b>					
SIZE	L1	L2	L3	D	PART NUMBERS
NW16	16	3.9	8		KS-16-133
NW25	25	3.9	8		KS-25-133
NW40	40	3.9	8		KS-40-133
NW50	50	3.9	8		KS-50-133

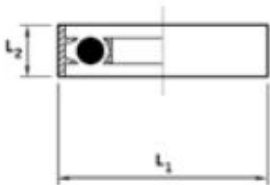

<b>TRAPPED O RING FLUOROELASTOMER / STAINLESS STEEL/ALUMINIUM</b>					
SIZE	L1	L2	L3	D	PART NUMBERS
NW10/16	32.5	7			KA-10-138
NW25	42.5	7			KA-25-138
NW40	57.5	7			KA-40-138
NW50	77.5	7			KA-50-138

# NW / KF VACUUM FITTINGS



<b>CO-SEAL FLUOROELASTOMER / STAINLESS STEEL</b>					
<b>SIZE</b>	<b>L1</b>	<b>L2</b>	<b>L3</b>	<b>D</b>	<b>PART NUMBERS</b>
NW10/16	32	7			B271-58-480
NW20/25	42	7			B271-58-490
NW32/40	57	7			B271-58-500

<b>CO-SEAL FLUOROELASTOMER / ALUMINIUM</b>					
<b>SIZE</b>	<b>L1</b>	<b>L2</b>	<b>L3</b>	<b>D</b>	<b>PART NUMBERS</b>
NW10/16	32	7			B271-58-481
NW20/25	42	7			B271-58-491
NW32/40	57	7			B271-58-501



<b>METAL SEALS ALUMINIUM</b>					
<b>SIZE</b>	<b>L1</b>	<b>L2</b>	<b>L3</b>	<b>D</b>	<b>PART NUMBERS</b>
NW10/16	32	7			C271-59-004
NW20/25	42	7			C271-59-005
NW32/40	57	7			C271-59-006
NW50	77	7			C271-59-007

# ISO VACUUM FITTINGS

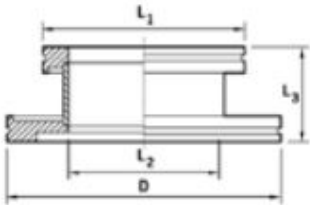

ISO/ISO ADAPTING PIECE - STAINLESS STEEL					
SIZE	L1	L2	L3	D	PART NUMBERS
ISO100/ISO63	95	70	50	130	IS-10-058
ISO160/ISO63	95	70	50	180	IS-16-058
ISO160/ISO100	130	102	50	180	IS-16-059

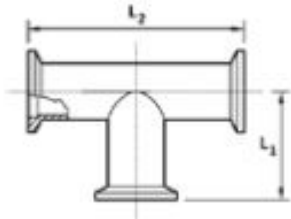

T-PIECE - STAINLESS STEEL					
SIZE	L1	L2	L3	D	PART NUMBERS
ISO63	88	176			IS-63-030
ISO100	108	216			IS-10-030
ISO160	138	276			IS-16-030

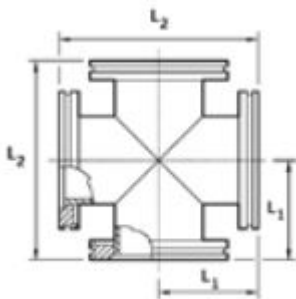

CROSS PIECE - STAINLESS STEEL					
SIZE	L1	L2	L3	D	PART NUMBERS
ISO63	88	176			IS-63-031
ISO100	108	216			IS-10-031
ISO160	138	276			IS-16-031

# ISO VACUUM FITTINGS

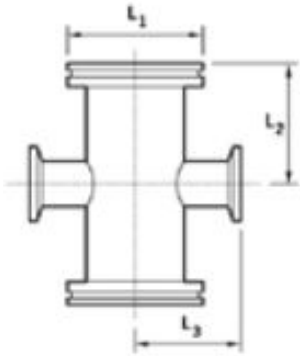

ISO TO NW REDUCING CROSS - STAINLESS STEEL					
SIZE	L1	L2	L3	D	PART NUMBERS
ISO63/NW16	95	102	58		IS-63-047
ISO63/NW25	95	102	79		IS-63-048
ISO63/NW40	95	102	76		IS-63-056
ISO100/NW25	130	130	98		IS-10-048
ISO100/NW40	130	130	95		IS-10-056
ISO160/NW40	180	160	121		IS-16-056
ISO160/NW50	180	160	136		IS-16-057



# ISO VACUUM FITTINGS

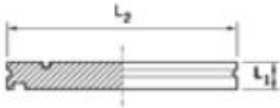

## BLANKING FLANGE FOR USE WITH COLLAR FLANGE - STAINLESS STEEL

SIZE	L1	L2	L3	D	PART NUMBERS
ISO63	12	95			IS-63-026
ISO100	12	130			IS-10-026
ISO160	12	180			IS-16-026

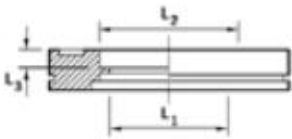

## ISO BORED FLANGE - STAINLESS STEEL

SIZE	L1	L2	L3	D	PART NUMBERS
ISO63	60.2	63.5	5.5		IS-63-061
ISO100	98.3	102	5.5		IS-10-061
ISO160	148	152	5.5		IS-16-061

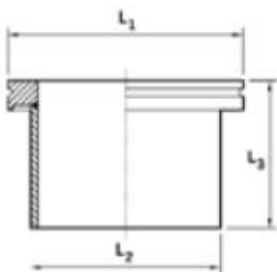

## COLLAR WELD STUB - STAINLESS STEEL

SIZE	L1	L2	L3	D	PART NUMBERS
ISO63	95	76	100		IS-63-025
ISO100	130	108	100		IS-10-025
ISO160	180	159	100		IS-16-025

# ISO VACUUM FITTINGS

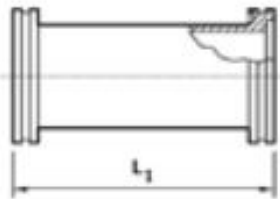

NIPPLE - STAINLESS STEEL					
SIZE	L1	L2	L3	D	PART NUMBERS
ISO63	176				IS-63-028
ISO100	216				IS-10-028
ISO160	276				IS-16-028

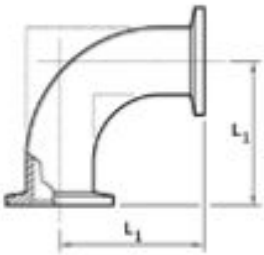

ELBOW 90° - STAINLESS STEEL					
SIZE	L1	L2	L3	D	PART NUMBERS
ISO63	88				IS-63-029
ISO100	108				IS-10-029
ISO160	138				IS-16-029



# ISO VACUUM FITTINGS

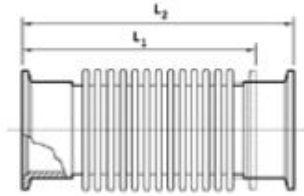

<b>FLEXIBLE BELLOWS - STAINLESS STEEL AISI 316L DIN 1.4404</b>					
SIZE	L1	L2	L3	D	PART NUMBERS
ISO63	130	150			IS-63-046
ISO100	130	150			IS-10-046
ISO160	130	150			IS-16-046

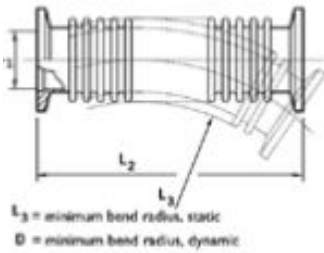

<b>FLEXIBLE PIPELINES - STAINLESS STEEL</b>					
SIZE	L1	L2	L3	D	PART NUMBERS
ISO63	250	140			IS-63-021
ISO100	250	200			IS-10-021
ISO63	500	140			IS-16-022
ISO100	500	200			IS-10-022
ISO63	1000	140			IS-63-023
ISO100	1000	200			IS-10-023



# ISO VACUUM FITTINGS

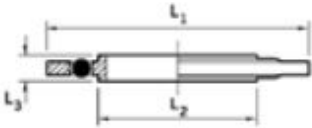

<b>TRAPPED O RING - STAINLESS STEEL / ALUMINIUM OUTER</b>					
<b>SIZE</b>	<b>L1</b>	<b>L2</b>	<b>L3</b>	<b>D</b>	<b>PART NUMBERS</b>
ISO63	95	70	8		IS-63-238
ISO100	128	102	8		IS-10-238
ISO160	179	153	8		IS-16-238

<b>TRAPPED O RING - *FLUROELASTOMER</b>					
<b>SIZE</b>	<b>L1</b>	<b>L2</b>	<b>L3</b>	<b>D</b>	<b>PART NUMBERS</b>
ISO63	95	70	8		IS-63-138
ISO100	128	102	8		IS-10-138
ISO160	179	153	8		IS-16-138



<b>TRAPPED O RING - ALUMINIUM CENTRING RING / ALUMINIUM OUTER RING / FLUROELASTOMER</b>					
<b>SIZE</b>	<b>L1</b>	<b>L2</b>	<b>L3</b>	<b>D</b>	<b>PART NUMBERS</b>
ISO63	95	70	8		IA-63-138
ISO100	128	102	8		IA-10-138
ISO160	179	153	8		IA-16-138

# ISO VACUUM FITTINGS

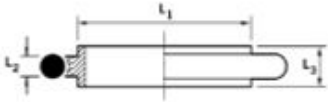

<b>CENTRING RING WITH O RING - STAINLESS STEEL / NITRILE</b>					
SIZE	L1	L2	L3	D	PART NUMBERS
ISO63	70	5.3	8		IS-63-227
ISO100	102	5.3	8		IS-10-227
ISO160	153	6.99	8		IS-16-227

<b>CENTRING RING WITH O RING - STAINLESS STEEL / FLUOROELASTOMER</b>					
SIZE	L1	L2	L3	D	PART NUMBERS
ISO63	70	5.3	8		IS-63-127
ISO100	102	5.3	8		IS-10-127
ISO160	153	6.99	8		IS-16-127

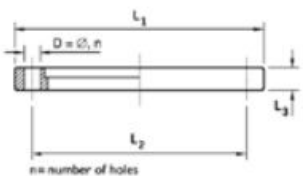

<b>ROTATABLE FLANGE WITH FITTING KIT - MILD STEEL NICKEL PLATED</b>					
SIZE	L1	L2	L3	D	PART NUMBERS
ISO63	130	110	12	9 4	IN-63-060
ISO100	165	145	12	9 8	IN-10-060
ISO160	225	200	16	11 8	IN-16-060

# ISO VACUUM FITTINGS

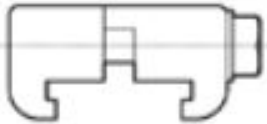

## CLAW CLAMPS - ALUMINIUM

SIZE	L1	L2	L3	D	PART NUMBERS
ISO63/100					IA-63-054
ISO160/250					IA-16-054
NUMBER REQUIRED: ISO63 - 4; ISO109 - 6; ISO160 - 8; ISO250 - 10					

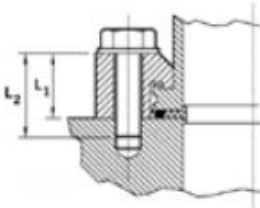

L3 =

## HALF CLAW CLAMPS FOR USE WITH CENTERING RING (TAPPED HOLES) - ZINC PLATED MILD STEEL BODY / STAINLESS BOLT

SIZE	L1	L2	L3	D	PART NUMBERS
ISO63	22.5	35	M8	4	IZ-63-052
ISO100	22.5	35	M8	8	IZ-10-052
ISO160	23	40	M10	8	IZ-16-052

## HALF CLAW CLAMPS FOR USE WITH CENTERING RING (CLEAR HOLE) - ZINC PLATED MILD STEEL BODY / STAINLESS BOLT

SIZE	L1	L2	L3	D	PART NUMBERS
ISO63	22.5	35	M8	4	IZ-63-053
ISO100	22.5	35	M8	8	IZ-10-053
ISO160	23	40	M10	8	IZ-16-053



TECHNICAL VACUUM EXCELLENCE SINCE 2008

MechaTech Systems Ltd  
Unit 9 Brunel Way  
Thornbury  
Bristol  
BS35 3UR UK

+44 (0) 1454 414723  
enquiries@mechatechsystems.co.uk



MechaTech Systems Ltd,  
Unit 9 Brunel Way,  
Thornbury Industrial Estate,  
Thornbury, Bristol, UK. BS35 3UR  
Registered in England and Wales No. 06469333

